OTP Speech Chip SC040G

1、Description

SC040G are single-chip voice synthesizing CMOS IC. They are embedded EPROM architecture, and OTP (One Time Programmable) Speech chip, Each body has one input and three I/O pins. Through accurate internal oscillation, external R_{osc} is unnecessary. It Support PWM or DAC output for voice. Thus any external component is not required. Maximum 62 voice groups. Serial trigger mode maximum 62 voice groups ,moble One Group contain several steps (voice section); Maximum 700 steps for all the Groups. Maximum 40 seconds Voice. Each Step can be define Trigger Mode, Output Status, Voice Section, Mute length, I/O Type & Simple Programming Function. Support three mode trigger IC (Stand Alone, Serial Trigger Mode). Easy use development system is for function selection and voice combination . PC download the ROM code by the OTP_Writer.

2、Funtions :

(1).MAX voice file : 700

- (2).MAX Trigger Groups : 62
- (3).MAX Step : 700
- (4).Operating Voltage range: 2.4V ~ 3.6V
- (5).Total Voice Duration : 40S (6K Samples)
- (6).I/O pin : 4
- (7).Voice output : PWM or DAC
- (8).Sequential Key : OKY1 -> 32 Groups. OKY2 -> 29 Groups. IO3-> 1 Group.
IO4-> 1 Group
- (9).Debounce time : 50 us or 10 ms
- (10)Step can change Trigger I/O Type, Trigger Mode & Output Status.
- (11).DIP8/SOP8 Package.
- (12).Three Mode Trigger IC :
- (13).Key Stand-alone Trigger Mode :
 - A. Edge/Level
 - B. Hold/Unhold
 - C. Retrigger/Irretrigger
- (14).Serial Trigger Mode :
Combinations of OKY1 to trigger maximum 62 Voice Group.

(15). Output status (for each Output pin):

- A. Stand by Status. (High/Low Status)
- B. Busy Low Active.
- C. Busy High Active.
- D. LED Flash at 6 Hz.
- E. LED Flash at 3 Hz.
- F. LED Flash at 1.5 Hz.
- G. PWM for LED Dimming Control.

3、PAD Description:



Pad No	Pad Name	Description
1	OKY2/NC	Key Stand-alone Trigger Mode : is used to trigger the maximum 28 Voice.
2	OKY1/DATA	Key Stand-alone Trigger Mode : is used to trigger the maximum 63 Voice. Serial Trigger Mode : is used to trigger the maximum 62 Voice Group
3	I03/RST	Key Stand-alone Trigger Mode : is used trigger Only One Group Serial Trigger Mode :is used to trigger reset Voice Group
4	I04/BUSY	Key Stand-alone Trigger Mode : is used trigger Only One Group. As Output PIN , Output the BUSY or Flash Signal
5	VSS	Connected to Ground.
6	PWM1	As a PWM PIN , can Directly drive the Speaker .
7	VDD	Power Supply PIN , Connected with a 0.1 uF to VSS.
8	PWM2/DAC	As a PWM or DAC PIN, PWM can Directly drive the Speaker

4、DC Electrical Characteristics:

4.1、Maximum Rating

Symbol	Rating	Unit
VDD~GND	-0.5 ~ +3.6	V
Top (operating)	-20 ~ +80	°C
Tst (storage)	-25 ~ +85	°C

4.2、DC Characteristics

Symbol	Parameter	Min.	Typ.	Max.	Unit	Condition
VDD	VDD	1.8	3.0	3.6	V	
I _{sb}	Standby current, VDD=3V		1	5	uA	VDD=3V, no load
	Operating current DD=3V		600	1000	uA	VDD=3V, no load
I _{od}	Output drive current		-10		mA	VDD=3V, Voh=1.0V
I _{os}	Output sink current		30		mA	VDD=3V, Voh=1.5V
I _{oh}	PWM1, PWM2 output current		-200		mA	VDD=3V, Voh=1.5V
I _{oi}			200			VDD=3V, Voi=1.5V

5、Play Rate:

1	2	3	4	5	6	7	8
24kHz	19.2 kHz	16 kHz	13.7 kHz	12 kHz	10.66kHz	9.6kHz	8.72 kHz
9	10	11	12	13	14	15	16
8kHz	7.38 kHz	6.85 kHz	6.4 kHz	6 kHz	5.64kHz	5.33kHz	5.05 kHz
17	18	19	20	21	22	23	24
4.8kHz	4.57kHz	4.36kHz	4.17kHz	4kHz	3.84kHz	3.69kHz	3.55kHz
25	26	27	28	29	30	31	32
3.42kHz	3.31kHz	3.2kHz	3kHz	-	-	-	-

6、Timing Diagram :

6.1、Key Stand-alone Trigger Mode

Only one input pin can select Toggle On/Off function (1st Trigg nput priority is OKY1>OKY2>I03>I04.

1. Trigger Pulse Width < Group Length

Option Setting =Edge / Hold



2. Trigger Pulse Width < Group Length

Option Setting = Edge / Unhold

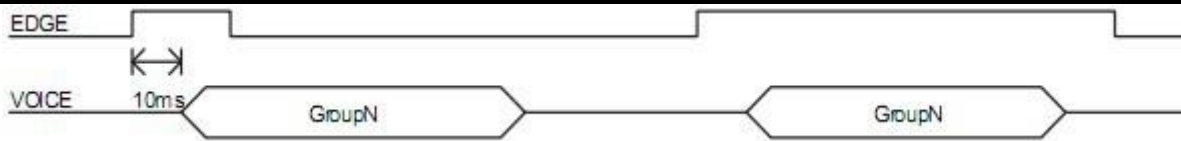

3. Option Setting = Retrigger



4. Option Setting = Irretrigger

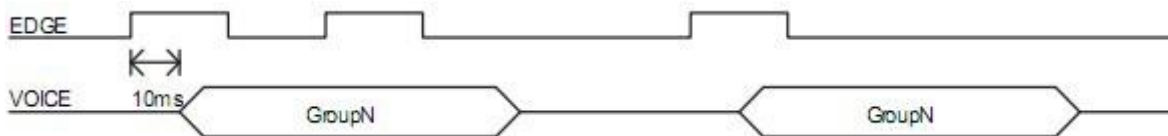

5. Trigger Pulse Width < Group Length

Option Setting = Level / Hold

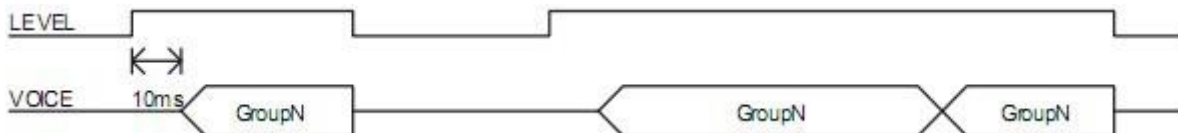

6. Trigger Pulse Width < Group Length

Option Setting = Level / Unhold

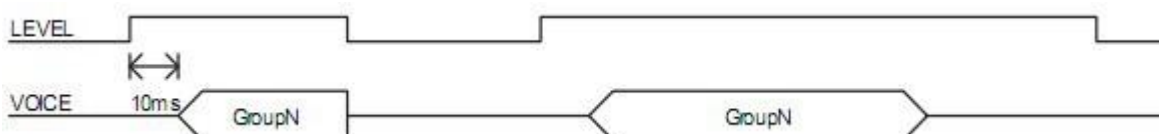

7. DATA= Sequential Trigger & From Group1~Group5

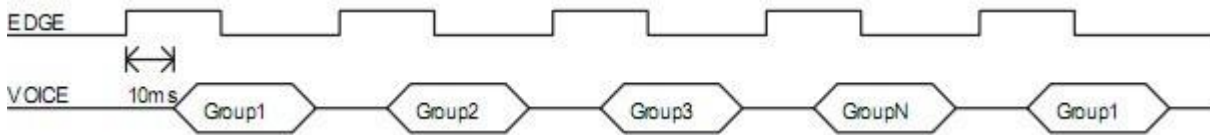

6.2、Serial PWM Mode Timing

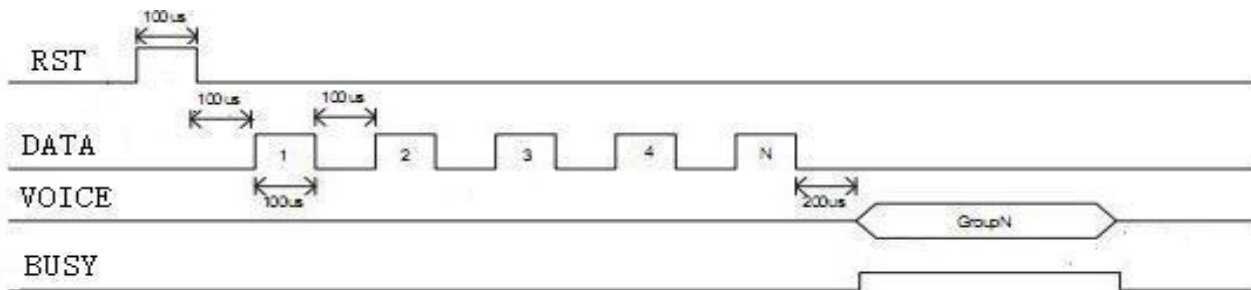

DATA=Edge/Unhol Trigger>50us

RST=Reset PIN .

6.3、Serial DAC Mode Timing

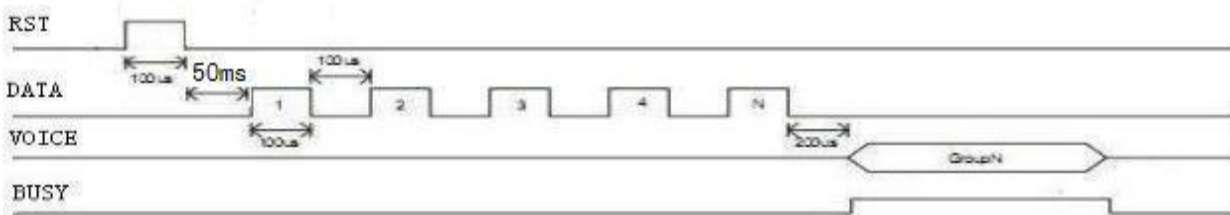

DATA=Edge/Unhol Trigger>50us RST trigger low > 50MS

RST=Reset PIN .

7、Application Circuit:

7.1、Stand-alone PWM Mode

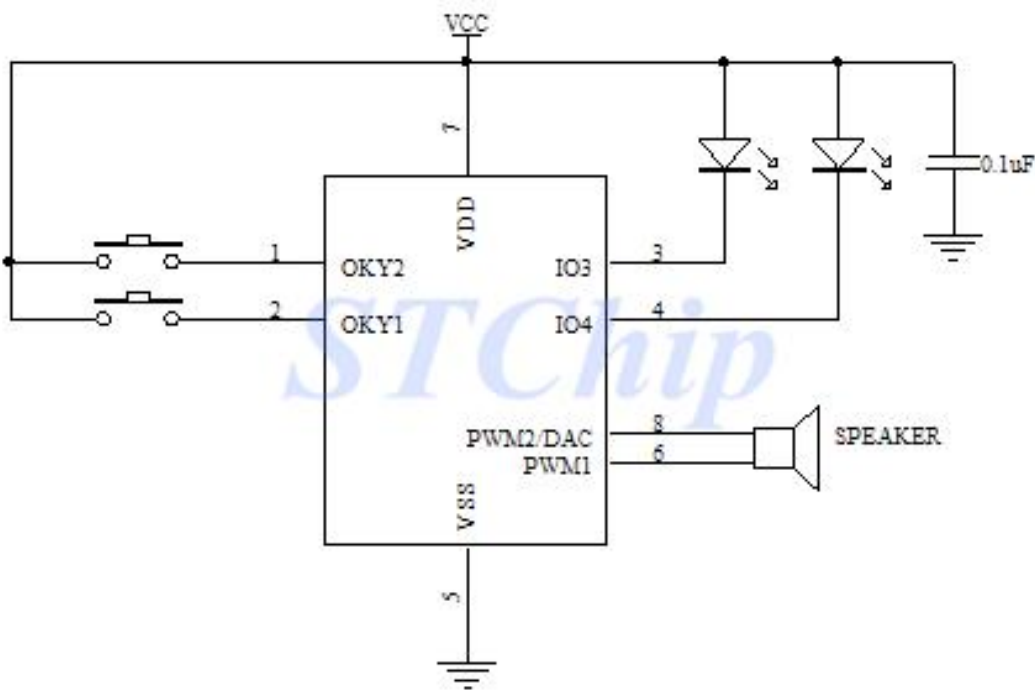

7.2、Stand-alone DAC Mode

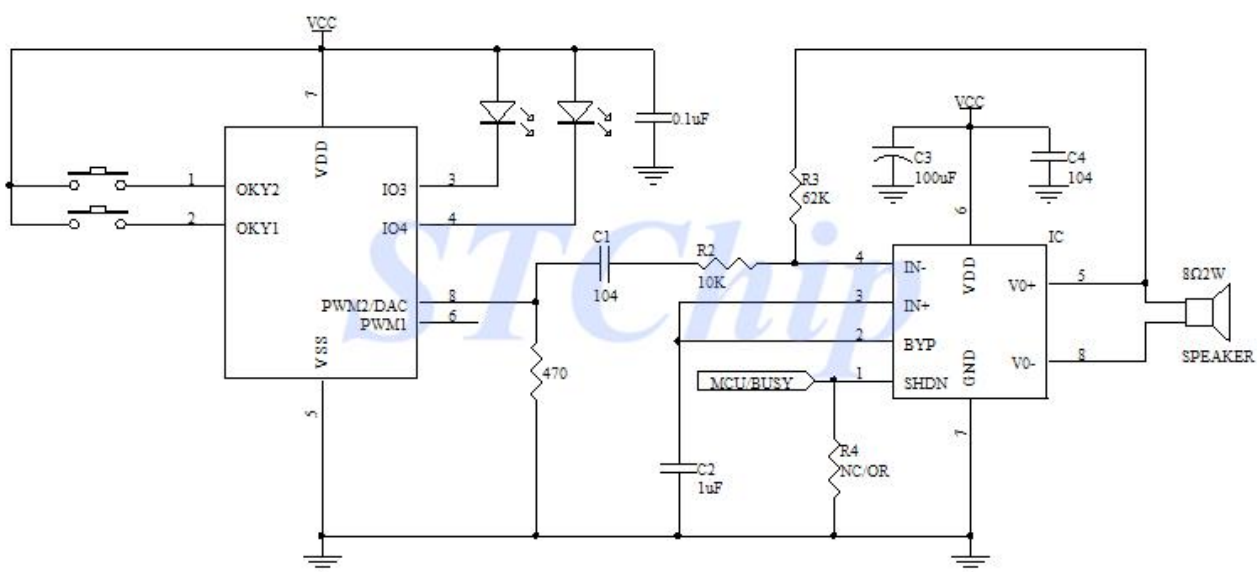

7.3、Serial PWM Mode

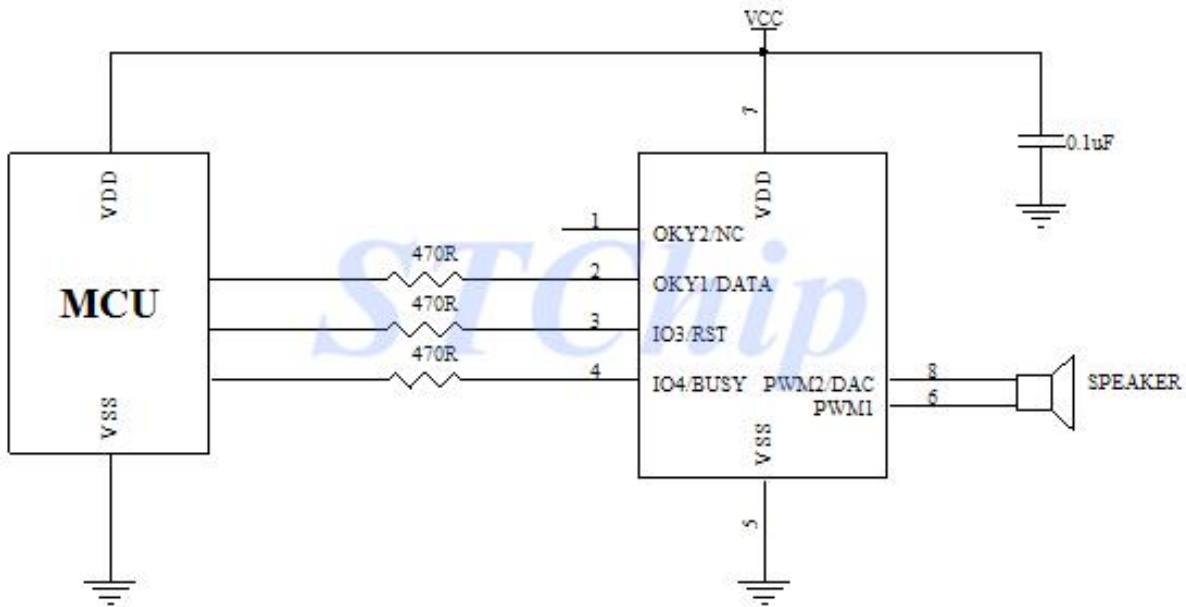

7.4、Serial DAC Mode

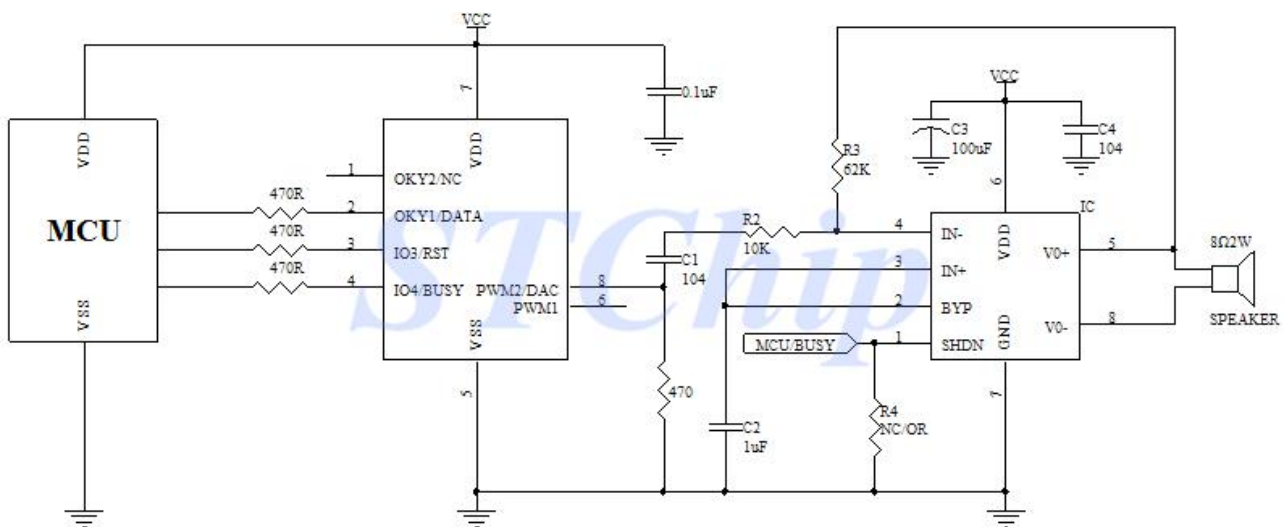

8、Package Information

1. DIP8 (300mil)

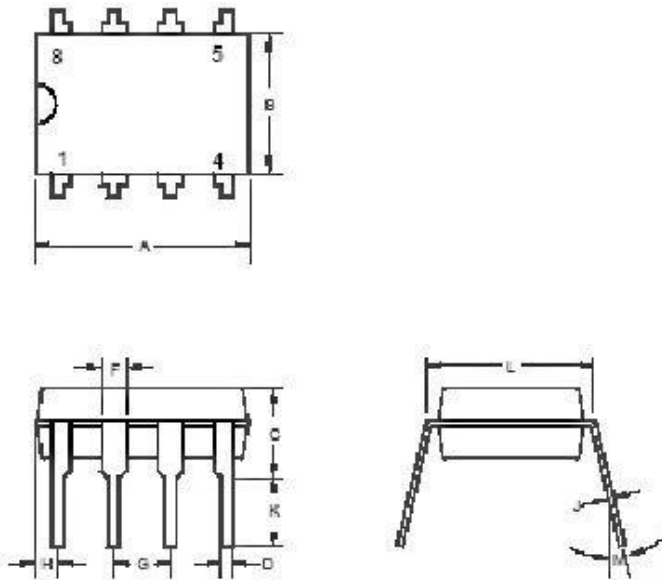

	INCHES			MILLIMETERS		
	MIN	TYP	MAX	MIN	TYP	MAX
A	0.355	0.365	0.400	9.02	9.27	10.16
B	0.240	0.250	0.280	6.10	6.35	7.11
C	-	-	0.210	-	-	5.33
D	-	0.018	-	-	0.46	-
F	-	0.060	-	-	1.52	-
G	-	0.100	-	-	2.54	-
H	0.050	-	0.090	1.27	-	2.29
J	0.008	-	0.015	0.20	-	0.38
K	0.115	0.130	0.150	2.92	3.30	3.81
L	0.300 BSC.			7.62 BSC.		
M	-	7°	15°	-	7°	15°

2. SOP8 (150miL)

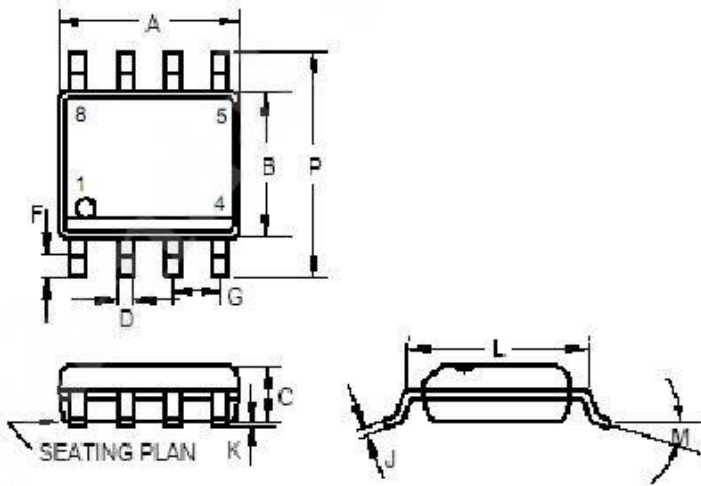

	INCHES			MILLIMETERS		
	MIN	TYP	MAX	MIN	TYP	MAX
A	0.183	-	0.202	4.65	-	5.13
B	0.144	-	0.163	3.66	-	4.14
C	0.068	-	0.074	1.35	-	1.88
D	0.010	-	0.020	0.25	-	0.51
F	0.015	-	0.035	0.38	-	0.89
G	0.050 BSC			1.27 BSC		
J	0.007	-	0.010	0.19	-	0.25
K	0.005	-	0.010	0.13	-	0.25
L	0.189	-	0.205	4.80	-	5.21
M	-	-	8°	-	-	8°
P	0.228	-	0.244	5.79	-	6.20